

**3M** ESPE

Lava™ Zirconia

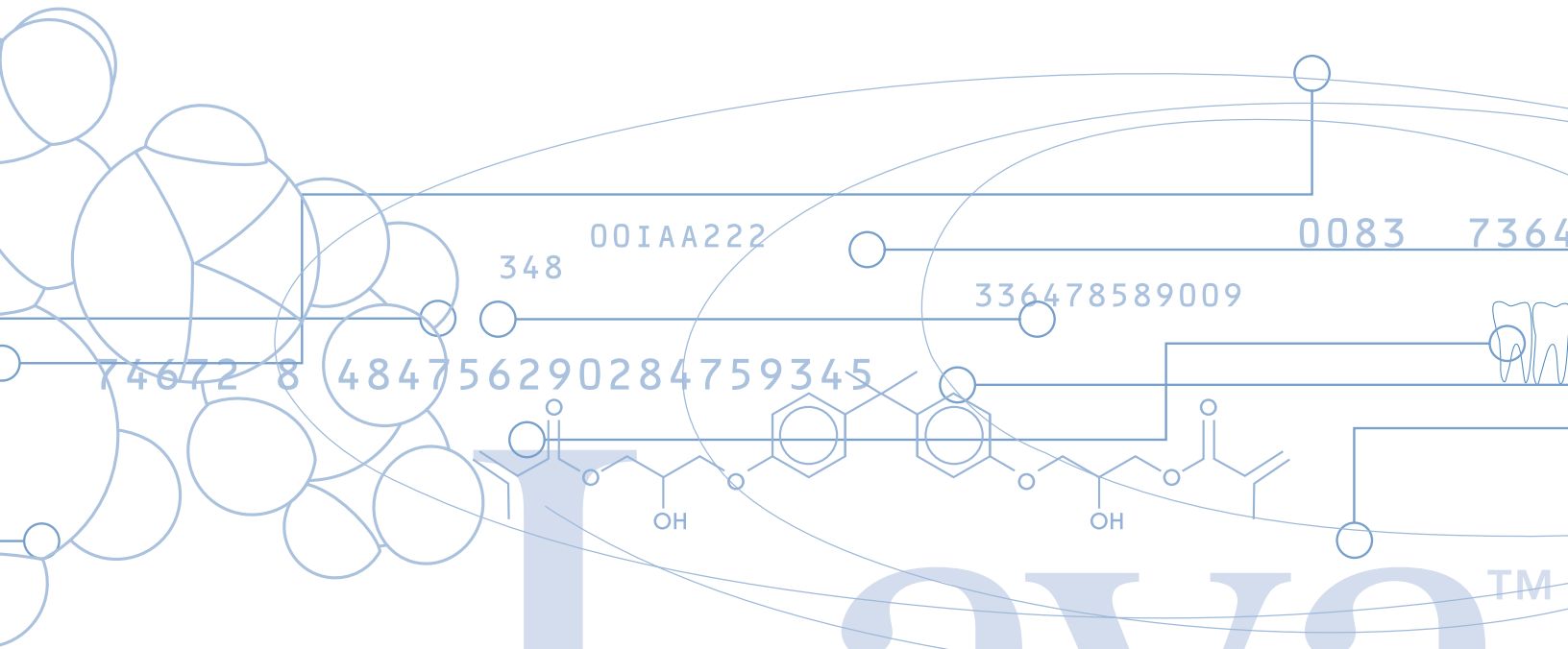

*Scientific  
Facts*



74672 8 484756290284759345 348 00IAA222 336478589009 0083 7364

CC(=O)OCC(O)COc1ccc(cc1)C2=CC=CC=C2C3=CC=CC=C3C4=CC=CC=C4C5=CC=CC=C5C6=CC=CC=C6C7=CC=CC=C7C8=CC=CC=C8C9=CC=CC=C9C10=CC=CC=C10C11=CC=CC=C11C12=CC=CC=C12C13=CC=CC=C13C14=CC=CC=C14C15=CC=CC=C15C16=CC=CC=C16C17=CC=CC=C17C18=CC=CC=C18C19=CC=CC=C19C20=CC=CC=C20C21=CC=CC=C21C22=CC=CC=C22C23=CC=CC=C23C24=CC=CC=C24C25=CC=CC=C25C26=CC=CC=C26C27=CC=CC=C27C28=CC=CC=C28C29=CC=CC=C29C30=CC=CC=C30C31=CC=CC=C31C32=CC=CC=C32C33=CC=CC=C33C34=CC=CC=C34C35=CC=CC=C35C36=CC=CC=C36C37=CC=CC=C37C38=CC=CC=C38C39=CC=CC=C39C40=CC=CC=C40C41=CC=CC=C41C42=CC=CC=C42C43=CC=CC=C43C44=CC=CC=C44C45=CC=CC=C45C46=CC=CC=C46C47=CC=CC=C47C48=CC=CC=C48C49=CC=CC=C49C50=CC=CC=C50C51=CC=CC=C51C52=CC=CC=C52C53=CC=CC=C53C54=CC=CC=C54C55=CC=CC=C55C56=CC=CC=C56C57=CC=CC=C57C58=CC=CC=C58C59=CC=CC=C59C60=CC=CC=C60C61=CC=CC=C61C62=CC=CC=C62C63=CC=CC=C63C64=CC=CC=C64C65=CC=CC=C65C66=CC=CC=C66C67=CC=CC=C67C68=CC=CC=C68C69=CC=CC=C69C70=CC=CC=C70C71=CC=CC=C71C72=CC=CC=C72C73=CC=CC=C73C74=CC=CC=C74C75=CC=CC=C75C76=CC=CC=C76C77=CC=CC=C77C78=CC=CC=C78C79=CC=CC=C79C80=CC=CC=C80C81=CC=CC=C81C82=CC=CC=C82C83=CC=CC=C83C84=CC=CC=C84C85=CC=CC=C85C86=CC=CC=C86C87=CC=CC=C87C88=CC=CC=C88C89=CC=CC=C89C90=CC=CC=C90C91=CC=CC=C91C92=CC=CC=C92C93=CC=CC=C93C94=CC=CC=C94C95=CC=CC=C95C96=CC=CC=C96C97=CC=CC=C97C98=CC=CC=C98C99=CC=CC=C99C100=CC=CC=C100  
**Lava**™

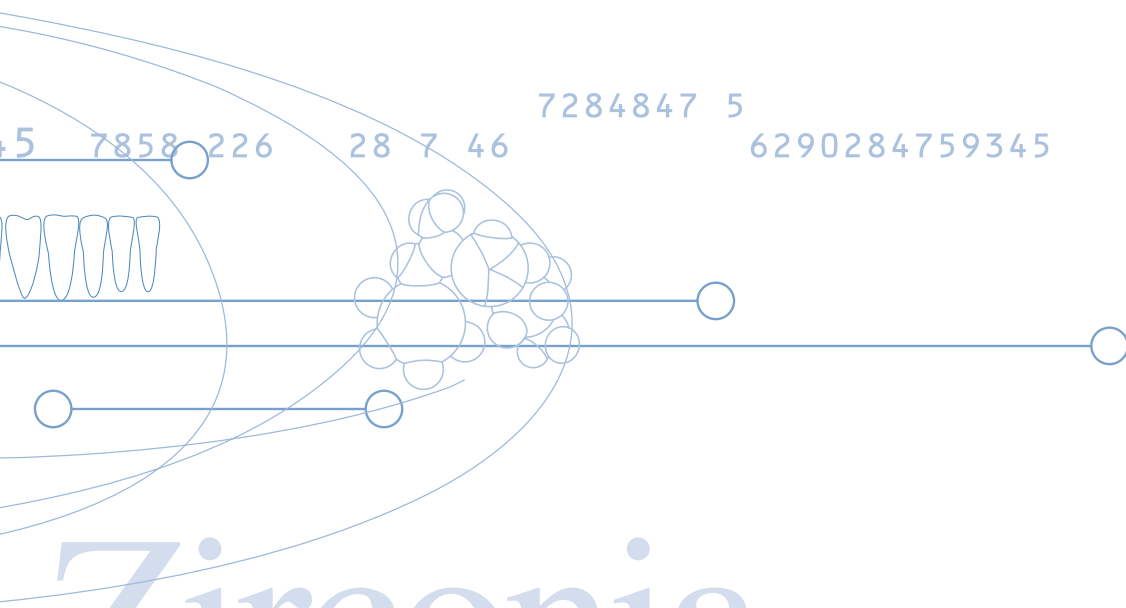

# Zirconia

## ARTICLES

Introduction .....	04
Zirconia is Not Alike .....	05
Zirconia and HIP Zirconia: Are There Differences? .....	07
Five-Year Clinical Evaluation .....	09
Marginal Fit .....	10
Translucency and Restoration Aesthetics .....	12
Sandblasting or Rocatec™ Treatment .....	13

# Introduction

## Are all zirconias the same?

Ceramic restorations in the posterior region were once limited to single units. CAD/CAM technology made it possible to prepare restorations out of high-strength ceramics. Now, with the introduction of zirconia as a dental material, clinicians can place multi-unit restorations in both the anterior and posterior regions. This is due in part to the high flexural strength and fracture toughness of zirconia.

Zirconia materials from different manufacturers, however, may be processed differently and have varying levels of stability. Not all manufacturers, for example, have completed adequate *in vitro* and *in vivo* clinical studies. Final restoration quality is directly dependent on careful and accurate control of the manufacturing process and thorough testing to substantiate material reliability.

## What can be different?

1. Processing parameters for pre-sintered zirconia affect performance attributes.
2. Differences in the zirconia powder affect the strength/long-term stability and translucency of the restoration.
3. The pressing condition and pressing method affect the marginal fit, strength and translucency of the restoration.
4. Pre-sintering conditions affect the strength of the pre-sintered material and its millability.
5. Coloring of the zirconia can affect the marginal fit, strength and translucency of the material.

## What should I be asking?

Clinicians should be mindful of what zirconia product they are receiving for their final restorations. Settling for a zirconia that is “just like the zirconia you asked for” shouldn’t be good enough. Dental professionals who educate themselves about the differences in zirconia should be asking their laboratory partners:

1. What brand of zirconia is being used? Why?
2. Is there good science and good clinical data behind this product?

Once dental professionals understand the differences in zirconia materials, it becomes much easier for them to choose the best material for their needs.

## Why Lava™ Zirconia?

This booklet includes five-year clinical results for 3M™ ESPE™ Lava™ Crowns and Bridges and compiles data on the material’s milling and fabrication process, marginal fit, translucency and aesthetics. Use the information to help you choose the right product and ensure you get exactly the properties you specified.

# Zirconia is not all alike!

CAD/CAM technology has made it possible to prepare restorations out of high strength ceramics like Alumina and Zirconia. Previously, ceramic restorations in the posterior region were limited to single units. Now with the introduction of Zirconia as a dental material, clinicians are able to place all ceramic restorations in the anterior and posterior regions. This is due in part to the high flexural strength (almost two times higher compared to Alumina) and high fracture toughness of the Zirconia ceramic material.

Several companies are offering Zirconia materials in dentistry. These materials are chemically similar, consisting of 3% Yttrium oxide treated Tetragonal Zirconia Polycrystals.

In many cases they are also treated with a very small concentration of Alumina (< 0,25 %) to prevent leaching of the Yttrium oxide. This combination ensures the safety and longevity of Zirconia restorations.

**Even though Zirconia can be chemically similar it is not necessarily the same.**

Bread is often chemically similar, however the colour, consistency and taste can be very different. Many other factors outside of chemistry influence the final result including the order in which ingredients are mixed, the grain size or consistency of the flour, and time and temperature used for incubating the dough. In addition, breads can be baked at different temperatures. Aside from the ingredients and baking process, other differences such as the skill of the baker can lead to a substantial difference in the final product.

Although the Zirconia ceramic is chemically similar, once processed, it can exhibit different mechanical and optical characteristics. Working with Zirconia, one can experience the differences in machinability (e.g. wet milling and dry milling) and in sintering (e.g. temperature for Vita™ YZ-Cube → 1530°C; temperature for 3M™ ESPE™ Lava™ frameworks → 1500°C; temperature for Cercon™ → 1350°C).

## What can be different?

In principle, there is pre-sintered Zirconia and HIP (hot isostatic pressing) Zirconia available on the market. The pre-sintered Zirconia is milled, when the material still has a soft, chalk-like consistency. For full density, it is sintered again after milling. HIP material is milled in the fully sintered state. This sheet describes the differences of pre-sintered Zirconia. For more information on HIP Zirconia see 3M ESPE's respective information sheet.

## Processing parameters for pre-sintered Zirconia effect performance attributes

Process Step	Processing Parameters	Performance Attributes
<b>Powder</b>	<ul style="list-style-type: none"> <li>• CO-Precipitated (most powders)</li> <li>• Mixed Oxide Process (cheaper)</li> <li>• Grain Size (0.07–0,3µm)</li> <li>• Spray Drying &amp; Organic additives</li> </ul>	<ul style="list-style-type: none"> <li>• Translucency</li> <li>• Strength</li> <li>• Longevity</li> <li>• Hydrolytic Stability</li> <li>• Sinter Behaviour</li> </ul>
<b>Pressing</b>	<ul style="list-style-type: none"> <li>• Axial Compacting</li> <li>• Isostatic Compacting</li> <li>• Pressure (800–3000 bar)</li> <li>• Clean Room (no imperfections by airborne impurities)</li> </ul>	<ul style="list-style-type: none"> <li>• Marginal Fit</li> <li>• Translucency</li> <li>• Strength</li> </ul>
<b>Pre-sintering</b>	<ul style="list-style-type: none"> <li>• Temperature</li> <li>• Time</li> </ul>	<ul style="list-style-type: none"> <li>• Marginal Fit</li> <li>• Machinability</li> </ul>
<b>Machining</b>		
<b>Colouring</b>	<ul style="list-style-type: none"> <li>• Pigments (part of the powder processing)</li> <li>• Liquids</li> </ul>	<ul style="list-style-type: none"> <li>• Marginal Fit</li> <li>• Translucency</li> <li>• Strength</li> <li>• Longevity</li> </ul>
<b>Final sintering</b>	<ul style="list-style-type: none"> <li>• Temperature (1360°C–1530°C)</li> <li>• Time</li> </ul>	<ul style="list-style-type: none"> <li>• Translucency</li> <li>• Strength</li> <li>• Longevity</li> <li>• Hydrolytic Stability</li> </ul>

Fig. 1 Main steps in the production process of pre-sintered Zirconia and the important parameters with their influence on clinical aspects.

# Zirconia is not all alike! (continued)

Pre-sintered Zirconia is prepared by three main steps (see Fig. 1). The Zirconia powder is pressed and pre-sintered. This usually occurs by the manufacturer. The dental lab mills the pre-sintered blank and then sinters the coping or framework to achieve full density.

The preparation of the pre-sintered blanks by the manufacturer differs depending on the Zirconia powder source and both the pressing and the pre-sintering conditions selected.

## 1) Powder

The available Zirconia powders can have different grain sizes, different distributions of the various grain sizes, and different additives (e.g. binder for the pressing step). The additives Yttrium oxide and Alumina can be distributed within the material in a variety of ways such as a homogeneous distribution throughout the whole material, higher concentration at grain borders, etc. The grain size has an effect on strength and transformation toughening, a special and key mechanical characteristic of Zirconia. Variations in grain size distribution affects the resulting porosity and hence the translucency of the material. The distribution of additives can affect the hydrothermal stability of the sintered material.

**Differences in the Zirconia powder effects the strength/long-term stability and translucency of the restoration.**



3M™ ESPE™ Lava™ Zirconia has five years of clinical performance, optimal translucency and high strength. You can find more clinical studies about these topics in the 3M ESPE publications shown above

## 2) Pressing conditions:

The powder is first pressed, which can be accomplished by different procedures (e.g. isostatically or axially). The pressing conditions are adjusted to get an optimized blank for the pre-sintering step. The pressing methodology influences the

homogeneity and the density distribution of the material and hence the marginal fit. The pressing conditions can lead to differences in strength, translucency and affect the final sintering temperature of the Zirconia.

**The pressing conditions and pressing method affect the marginal fit, strength and translucency of the restoration.**



3M™ ESPE™ Lava™ Zirconia has shown an excellent marginal fit and optimal translucency. You can find more clinical studies about these topics in the 3M ESPE publication shown above.

## 3) Pre-sintering:

The pressed Zirconia powder is then pre-sintered in a furnace with an optimized temperature profile to generate a blank with suitable strength and millability.

**Pre-sintering conditions affect the strength of the pre-sintered material and its millability.**

## 4) Colouring:

Some Zirconia materials can be coloured in the pre-sintered state by immersing copings and frameworks in a dyeing liquid. This enables the absorption of colouring agents in the Zirconia material. Colouring can be achieved either by pigments (grains) or non-pigmented (ions) agents. It is important to control the effect of the dyeing liquid on the mechanical characteristics of the Zirconia material.

**Colouring of the Zirconia can affect the marginal fit, strength and translucency of the material.**

Dyed 3M™ ESPE™ Lava™ Zirconia shows high strength, excellent marginal fit and translucency. You can find more clinical studies about these topics in the 3M ESPE publications shown above.

**In summary, Zirconia in dentistry is chemically similar, but not necessarily alike.**



# Zirconia and HIP Zirconia: Are There Differences?

In order to answer this question, an understanding and definition of the mechanical properties of ceramic materials and zirconia is needed.

## Zirconia

Zirconia material typically used today by most manufacturers is tetragonal polycrystalline zirconia, partially stabilized with yttrium oxide. It should be noted that there also are varieties among the 3Y TZP materials. Although all of these materials have the same chemical composition, there are differences in strength and translucency, based on the chosen powder type and the production conditions. Some of the zirconia materials on the market have a strength of 900 MPa, whereas others exhibit strength values over 1,100 MPa.

The apparent translucency of zirconia is very important; some zirconias exhibit a bright white, rather opaque color while others do not. Accordingly, it is essential to choose the right 3Y TZP type and optimize the production conditions in order to achieve maximum strength and translucency. The processing of the blanks used by CAD/CAM systems, incorporating the green machining approach typically is achieved by utilizing a spray-dried zirconia powder. This powder can be isostatically pressed, pre-sintered and then mounted in a holder to be placed in a CAD/CAM system. After milling in the pre-sintered state, the enlarged geometry is sintered pressureless in a furnace at temperatures between 1,350°C and 1,500°C. The porous pre-sintered zirconia shape shrinks by approximately 20% linear, thus achieving its strength and optical properties.

## HIP zirconia

HIP stands for “Hot Isostatic Pressing.” This is a special sintering technique used in the ceramic industry and necessitates expensive equipment. By means of comparison, in a closed system, high temperatures and pressures are applied to densify the material a bit more than the non-HIP zirconia, gaining approximately 20% more in strength. It should be noted that HIP zirconia is not a particularly special material. The chemical composition of HIP zirconia is exactly the same as that which is utilized for the green machining approach.



Any improved properties of HIP zirconia are counterbalanced by the fact that grinding a 1/1 shape from the material introduces substantial amounts of surface defects. During milling of dense sintered ceramic blanks, there also is the danger of unwanted surface and structural defects on the ceramic. Caused by diamond burs, these also negatively impact the permanent strength of the ceramics. Compared with green processing, the hard processing of dense sintered zirconia with diamond burs is more time and labor intensive and also involves increased wear on the milling instruments.

## Differences between zirconia and HIP zirconia

- HIP zirconia has the same chemical composition as a non-HIP zirconia.
- HIP is a sintering process, not a material.
- HIP zirconia minimizes overall restoration strength, since during the grinding of the shape out of a dense HIP zirconia block, surface defects are introduced. As an example, an *in vitro* study from Dr. J. Tinschert, University of Aachen, clearly demonstrates that there is no advantage to utilizing HIP zirconia vs. non-HIP zirconia. (Initial fracture force [in N] of 3 and 4 unit bridges using HIP and non-HIP zirconia material [DCS = HIP zirconia, Lava = non-HIP zirconia]).

# Zirconia and HIP Zirconia: Are There Differences? *continued*

## General Information

### Definition of units

There is a difference between whether a fracture force in N (Newton) or a strength value in MPa is stated, which is a load-per-square mm. N is a description of a pure force. Therefore, in the case of real dental geometries (crowns and bridges) the fracture force is measured in N. MPa is a description of a force-per-square mm. In order to measure a strength value in MPa, one has to know the exact geometry of the specimen. In case of material discs or bars with exactly determined dimension, the fracture strength is measured in MPa.

### Data evaluation

When data on fracture is published and compared, it is important to understand what has been measured and what constituted the test set-up.

### Test methods

With regard to test set-ups, there also is a difference between the values (i.e., whether it has been a compression or a bending test). It is essential to know that ceramic materials have strength values about five-to-ten times higher in a compression test than with a bending or tensile test. However, any ceramic restoration will always fail in tension. The compressive strength of a ceramic material thus has little bearing on its quality. ▣

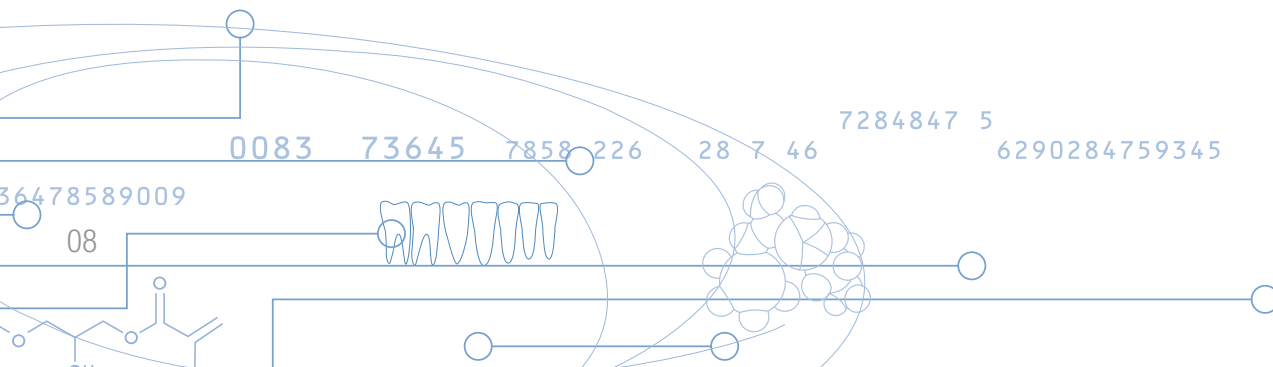
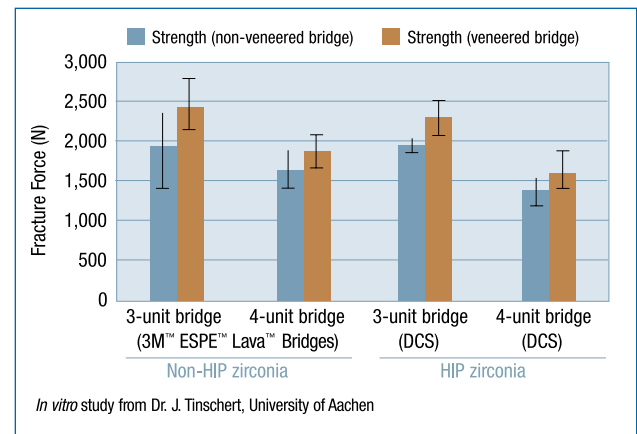



# Lava™ Crowns and Bridges Five-Year Clinical Evaluation

The introduction of high strength ceramics like alumina and zirconia allowed, for the first time in dentistry, the use of ceramic materials for bridge design in the posterior region. Zirconia is a material regarded as having the highest strength and fracture toughness in dentistry. Many *in vitro* studies show the excellent mechanical properties of zirconia compared to other ceramic materials. Clinical studies confirm the results of the *in vitro* tests. Long term results are on-going. Five year clinical results for 3M™ ESPE™ Lava™ Crowns and Bridges, one of the first commercially available zirconia systems, are now available. Prof. P. Pospiech together with Dr. F. P. Nothdurft and Dr. P. R. Rountree from the University of Munich recently published their data at the Conference of the Pan European Federation of the IADR in Dublin (Ireland).

Thirty-one bridges were placed beginning in October, 2000. All abutment teeth were prepared for full crowns with a maximum 1.2 mm chamfer. Impressions were made with a polyether material (Impregum™ F Polyether from 3M ESPE). All restorations were cemented conventionally with the glass-ionomer cement Ketac™ Cem from 3M ESPE. Recalls took place after one year, three years, and in March, 2006 after a five year observation period. At each recall the fit of the restoration, occurrences of secondary caries, fracture, discolouration of the marginal gingiva, and allergic reactions were recorded.



fig. 1 Five-year recall, 3-unit bridge, lower left first molar, buccal view

After five years, 15 bridges could be evaluated clinically. The survival of six bridges could be confirmed by questioning patients by phone. One bridge was lost for endodontic reasons after one year in service. One patient wearing two bridges died after the three year recall. Seven patients could not be recalled (the last recall examinations were conducted at the three year mark for these patients).

	3-year recall	5-year recall
Bridges in situ	100%	100%
Restorations examined	30	21
Fracture of framework	None	None
Chippings of the overlay porcelain	1	5

After five years, no failures were recorded. Slight chipping of veneering porcelain was seen in some cases but did not warrant repair or replacement. No allergenic reactions or negative influences on the marginal gingiva were observed.

The clinicians observed a high level of performance for Lava zirconia-based posterior bridges after five years of clinical service.

Please see the original abstract under <http://iadr.confex.com/iadr/htsearch.cgi> (Search for: Pospiech, Restrict searches to: 2006 PEF 2006).



fig. 2 Five-year recall, 3-unit bridge, lower left first molar, lingual view

# Lava™ Crowns and Bridges Marginal Fit

Marginal fit is an important characteristic that can contribute to clinical performance. Having said that, the maximum tolerance needed to prevent damage of the pulp and/or development of secondary caries by intrusion of bacteria and toxins is still a matter of debate among researchers.

Nevertheless, the dentist and dental technician need to precisely control and optimize the fit of the restoration with the respective production technology used for fabrication. When using CAD/CAM technology, the fit can be set for each abutment tooth in the software (e.g., 3M™ ESPE™ Lava™ Crowns and Bridges) which customizes the marginal gap for the clinical situation. The accuracy and ability of all CAD/CAM technologies to implement the predetermined fit depends on the accuracy of the entire system from the scanning device, milling material and milling unit. In the case of pre-sintered ceramic (e.g. Zirconia), the homogeneity of the material is especially important as it controls shrinkage during the final sintering process. The accuracy of the entire CAD/CAM system is a responsibility of the manufacturers.

Different methods were used in the literature to determine the fit of a restoration, which made it difficult to compare the various studies. The first important step was done by Holmes et al<sup>1</sup> (1989) who established uniform terminology including marginal gap, absolute marginal gap, vertical marginal gap, horizontal marginal gap, as well as over- and under-extension. [fig. 1]

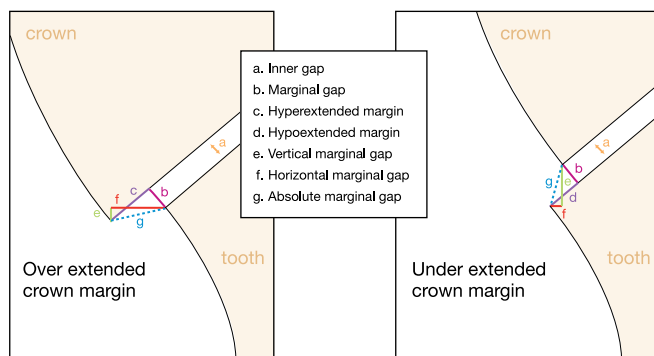

fig. 1 Terminology for fit determination of restorations according to Holmes et al. (1989)<sup>1</sup>

Several authors determined the gap of Lava™ Crowns and Bridges restorations in comparison to other Zirconia restorations fabricated with their respective CAD/CAM systems.

Dr. A. Piwowarczyk and Prof. Lauer of the University of Frankfurt published at the conference of the European division of the International Association of Dental Research (IADR, PEF) in 2006<sup>2</sup> a thorough analysis on the marginal gap and absolute marginal gap of 4-unit Zirconia bridges made out of Lava™ Zirconia and by the Lava™ system in comparison to Cercon and DCS President bridges. All restorations were anonymously ordered at milling centres or laboratories. [fig. 2a, 2b] Lava™ Crowns and Bridges showed the lowest marginal and absolute marginal gap.

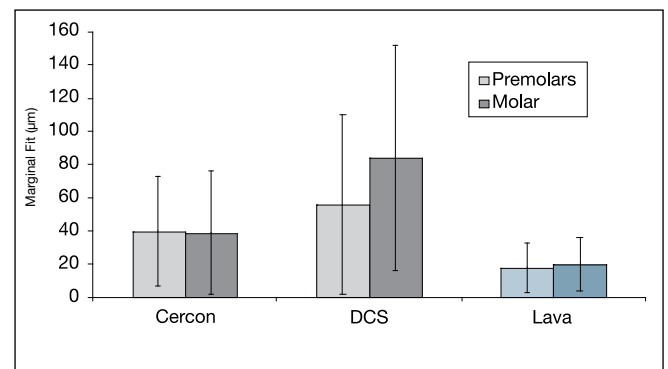

fig. 2a Marginal gap of 4-unit zirconia 3M™ ESPE™ Lava™ Bridges in comparison to competitor systems. A. Piwowarczyk and H.C. Lauer, University of Frankfurt.<sup>2</sup>

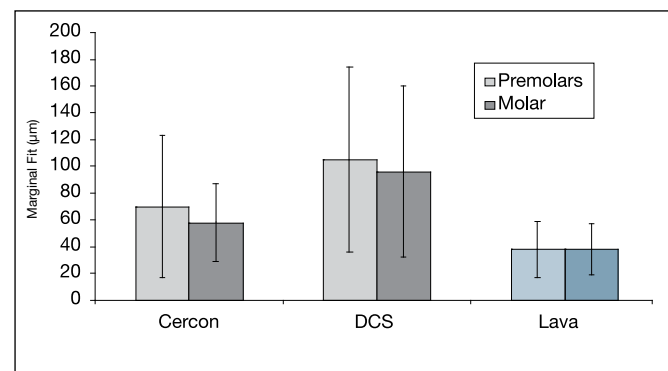

fig. 2b Absolute marginal gap of 4-unit zirconia 3M™ ESPE™ Lava™ Bridges in comparison to competitor systems. A. Piwowarczyk and H.C. Lauer, University of Frankfurt.<sup>2</sup>

# Lava™ Crowns and Bridges Marginal Fit

Dr. F. Beuer et al. (2005, 2006)<sup>3</sup> analyzed 3-unit Zirconia bridges made of 3M™ ESPE™ Lava™ Zirconia in comparison to Etkon (es1), Cercon brain, Cerec inLab and measured a very small marginal gap for Lava™ bridges. [Fig. 3]

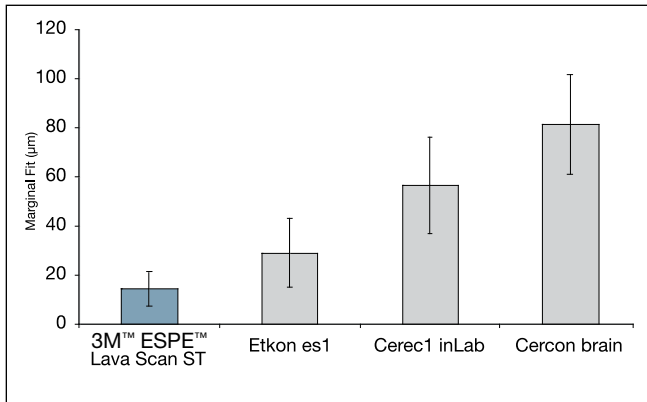

fig. 3 Marginal gap of 3-unit zirconia 3M™ ESPE™ Lava™ Bridges in comparison to competitor systems. F. Beuer et al., University of Munich.<sup>3</sup>

In summary, the Lava™ CAD/CAM system in combination with the Lava™ Zirconia results in an excellent fit of the restorations independent of the measure used. This shows not only the high accuracy of the scanning and milling device, but also the high homogeneity of the Zirconia material. □

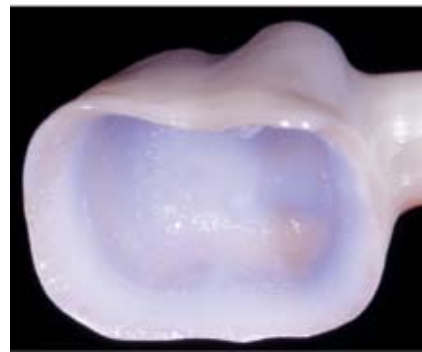

fig. 5 Excellent marginal fit of 3-unit 3M™ ESPE™ Lava™ Zirconia bridge in vivo: The fit has been checked in vivo before placement of the restoration. The accuracy of the fit is shown by the thin layer of fit checker. Courtesy of Prof. Dr. D. Edelhoff, University of Munich.

Moreover, A.J.T. Shannon, F. Qian, P. Tan, and D. Gratton published at the IADR meeting in 2007<sup>4</sup> a comparison of the vertical marginal gap of Zirconia copings fabricated by different CAD/CAM systems [including KaVo Everest (ZH, ZS), Nobel Biocare Procera (MOD40, Piccolo, Forte), Lava™ Crowns and Bridges, Wieland Zeno, and Cerec inLab (InCeramZr)] and compared their vertical marginal gap to control cast copings. Only the Lava™ copings showed no significant difference in fit to the control. [fig. 4]

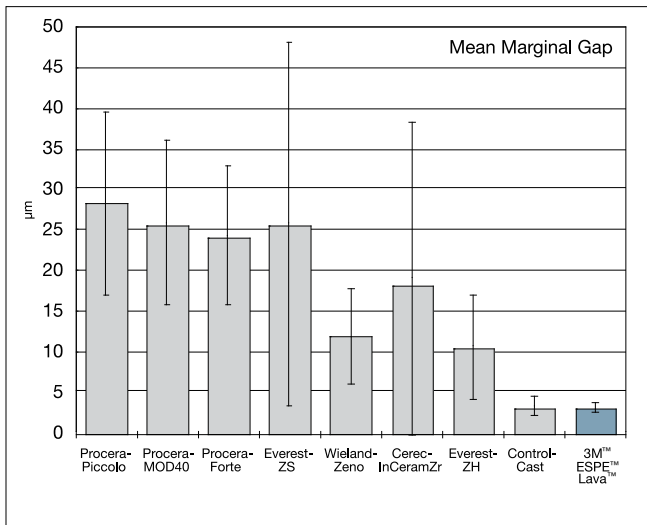

fig. 4 Vertical marginal gap of 3M™ ESPE™ Lava™ Copings in comparison to competitor systems. A.J.T. Shannon et al., University of Iowa.<sup>4</sup>

1. Holmes JR, Bayne SC, Holland GA, Sulik WD. (1989) Considerations in measurement of marginal fit. J. Prosthet Dent 62, 405-408
2. A. Piwowarczyk, H.-C. Lauer (2006), Determining the marginal fit of CAD/CAM bridge frameworks, Pan European Federation Conference (PEF; CED) #0254
3. F. Beuer, T. Fischer, K.-J. Erdelt, H.-U. Aggstaller, K. Spiegl, W. Gernet; (2005) IADR #1336 and In vitro Study Marginal fit of Lava™ restorations; F. Beuer, T. Fischer, K.-J. Erdelt, H.-U. Aggstaller, K. Spiegl, W. Gernet, industrial report (2006)
4. A.J.T. Shannon, F. Qian, P. Tan, D. Gratton (2007) In-Vitro Vertical Marginal Gap Comparison of CAD/CAM Zirconium Copings, IADR #0828

# Translucency and Restoration Aesthetics

In the last two decades, full ceramic restorations have become increasingly popular thanks to their aesthetics when compared to PFM restorations. Ceramic materials have a tooth-like color and can be shaded to match the natural adjacent tooth resulting in a higher overall aesthetic and greater patient satisfaction. Aesthetics is of course a very subjective attribute, but it can be evaluated by analyzing characteristics such as color (shade match) and translucency of the material as these seem to have the greatest influence on the patient's perception of the dental restoration.

Translucency describes the property that allows light to partially pass through and partially reflect. It has the effect of making the translucent area appear smoky or cloudlike, thus revealing objects behind. [P. Keller and M. Keller, Visual Cues, 1994, IEEE Computer Society Press] The translucency of a ceramic is determined by the amount of light intensity which is reflected, absorbed or scattered. [fig. 1] Translucency also depends on the material's color (absorbed light intensity of specific wavelength), its thickness and the structure and porosity of the ceramic. If the structure changes, light can be reflected and scattered in different ways.

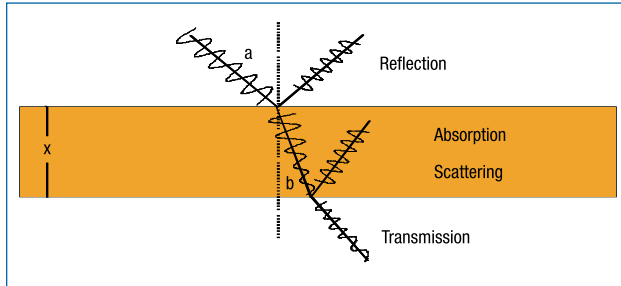

fig. 1 Ceramic translucency factors

The translucency of the core ceramic material is an especially important factor. Prof. R. Scotti, Prof. P. Baldissara, Dr. A. Llukacej, Dr. L. F. Valandro and Prof. M. A. Bottino analyzed and compared the translucency of different zirconia high-strength ceramic materials and published their results at the Academy

of Dental Materials Conference in 2006. [Abstract 103] From a standard stainless steel crown, model impressions were taken and the corresponding plaster models were fabricated. The models were sent to different authorized laboratories equipped with the respective CAD/CAM systems in order to prepare five copings out of each zirconia material.

Translucency was subsequently determined by measuring the light intensity (lux) transmitted through the specimens and detected by a photo-radiometer. Three measurements were taken for each specimen and the different zirconia materials were statistically analyzed with One-Way ANOVA, Bonferroni ( $\alpha=0,05$ ). [fig. 2]

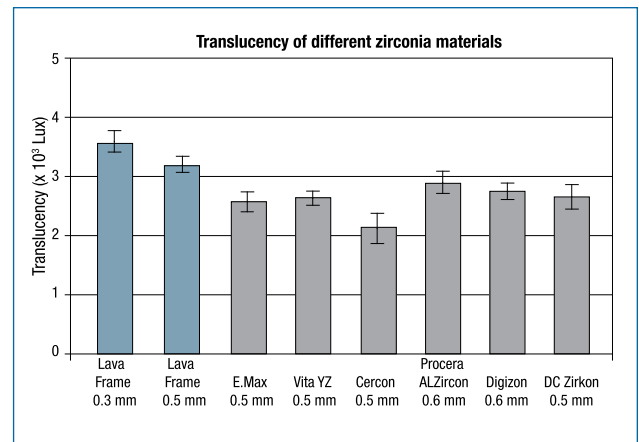
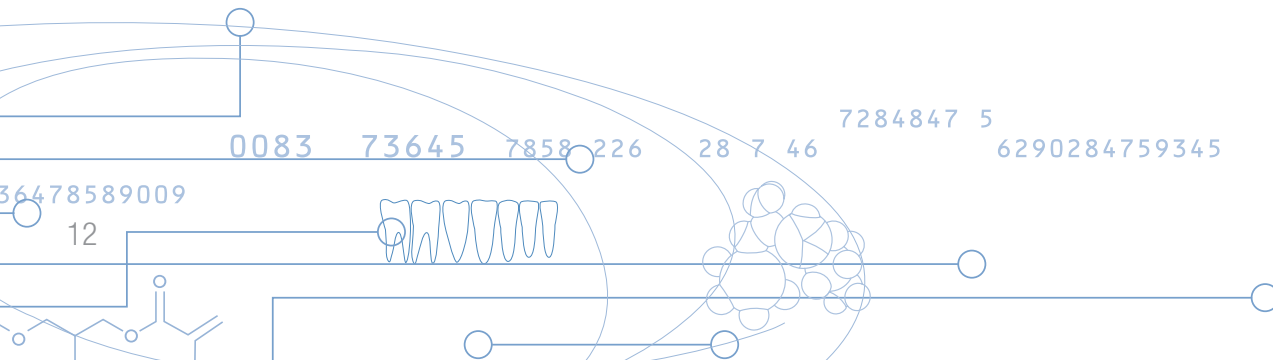

fig. 2 Light intensity transmitted through zirconia copings as detected by photo-radiometer

The study demonstrates that different zirconia materials, though chemically similar are not necessarily alike. 3M™ ESPE™ Lava™ Zirconia shows a significantly higher translucency among the specimens of the same thickness. Moreover, because Lava restorations only require a wall thickness of 0.3 mm in the anterior, the translucency is significantly increased when wall thickness is reduced from 0.5 to 0.3 mm. Lava zirconia with a 0.3 mm and 0.5 mm thickness are a very suitable material for restoration of anterior teeth with regards to aesthetics. ▣



# Sandblasting or Rocatec™ Treatment

Is it necessary or recommended to sandblast zirconia? The main concerns question whether sandblasting impacts the strength and long-term stability of the material. As sandblasting and treatment with the 3M™ ESPE™ Rocatec™ System are similar processes [bombardment of the material with particles (sandblasting), or coated particles (Rocatec™ treatment)], 3M ESPE has tested both procedures with its own Lava™ Zirconia and found no reduction in strength while using < 50µm particles for sandblasting and/or Rocatec™ Soft bonding treatment.

## Why sandblast a material?

When sandblasting a material it is bombarded by particles of different grain sizes. The aim of sandblasting is to increase the surface area and obtain higher surface roughness and/or to purify the material.

In general, the intaglio surface of the restoration is sandblasted in order to get a higher surface. The cement can optimally wet the larger interface resulting in better mechanical retention of the restoration. Often, the outer surface of the restoration framework has been sandblasted for the same reason to optimize the interface to the veneering. However, in the case of CAD/CAM milled Lava zirconia restorations, the sandblasting of the outer surface is not necessary, because of the roughness of the restoration, as milled, and the good wetting behavior of the Lava™ Ceram modifier. In addition, transformation processes may occur on the outer surface resulting in a change in the CTE of the material, which is not desirable even though this phenomenon has not been found to be critical for Lava zirconia.

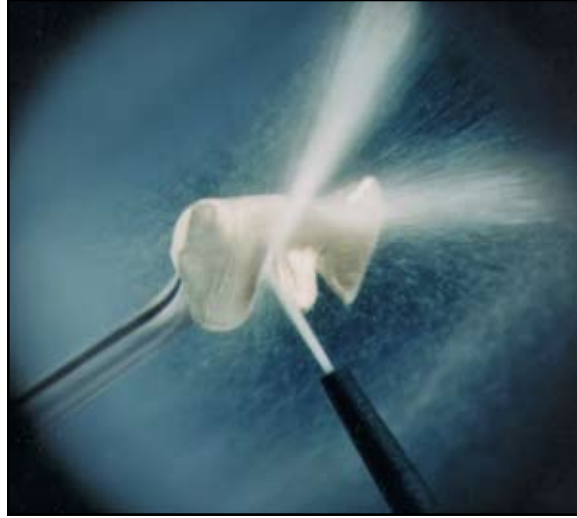

## Why Rocatec/Cojet™ treatment (silicatization and silanization)?

For chemical bonding with an adhesive cement, glass ceramic materials are etched by hydrofluoric acid (HF) in order to increase the surface and are subsequently silanized to get a chemical bonding between the inorganic ceramic material and the organic resin material of the cement. In the case of zirconia, this is not possible due to the special chemistry of the material; furthermore, zirconia has no specific groups to bond to the silanization agent (e.g., 3M™ ESPE™ Sil). Therefore, the zirconia has to be treated with Rocatec Soft bonding material. Through this treatment, by tribochemical reaction, the surface of the zirconia is coated with small particles of silicium oxide. These can bind to the silanization agent (3M™ ESPE™ Sil) and establish a chemical bonding to the adhesive resin cement.

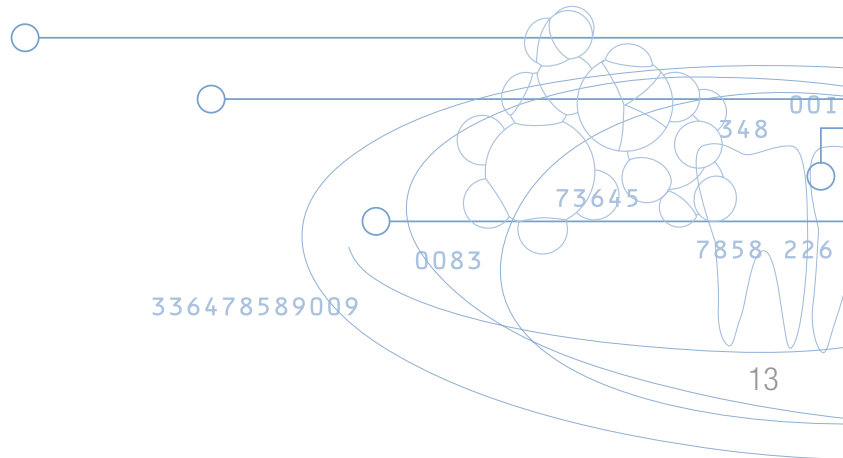

## Sandblasting or Rocatec™ Treatment *continued*

### Do sandblasting or Rocatec™ treatments have any impact on the strength of Lava™ Zirconia?

#### Sandblasting

Dr. G. Fleming from the University of Birmingham analyzed the effect of sandblasting with different grain sizes on the strength of the Lava zirconia material. He found no significant reduction by sandblasting with particle sizes of  $< 50\mu\text{m}$ . [fig. 1] This was further confirmed by Dr. M. Blatz and his group from Louisiana State University in New Orleans. There was no reduction in strength while sandblasting Lava zirconia. [fig. 2]

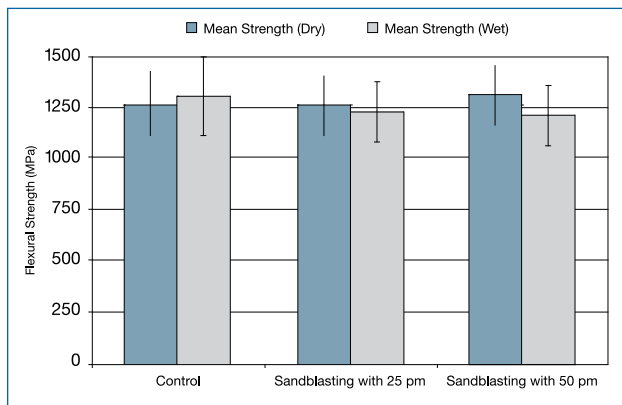

fig. 1 No strength reduction after sandblasting of 3M™ ESPE™ Lava™ Zirconia with different particle sizes; Dr. G.J.P. Fleming et al. (2005)

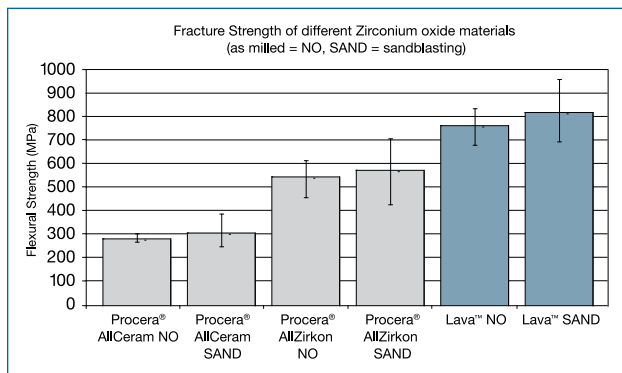

fig. 2 No strength reduction after sandblasting of different ceramic materials

#### Rocatec™ System

Silicatisation with Rocatec Soft bonding material does not significantly decrease the strength of the material. Additionally, after artificial aging by cyclic loading and thermocycling, the strength of the Rocatec Soft-treated Lava zirconia is not effected (fig. 3).

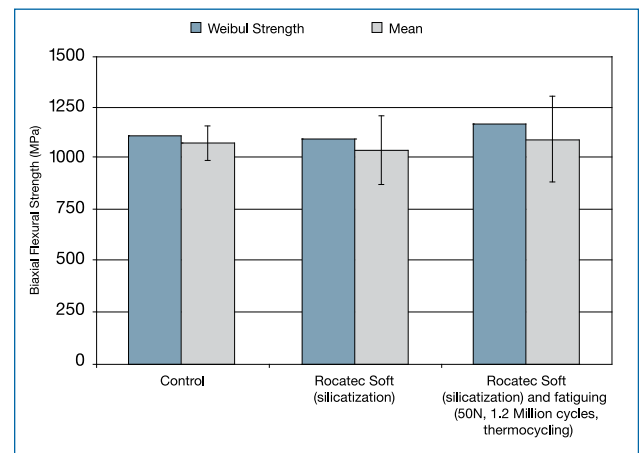
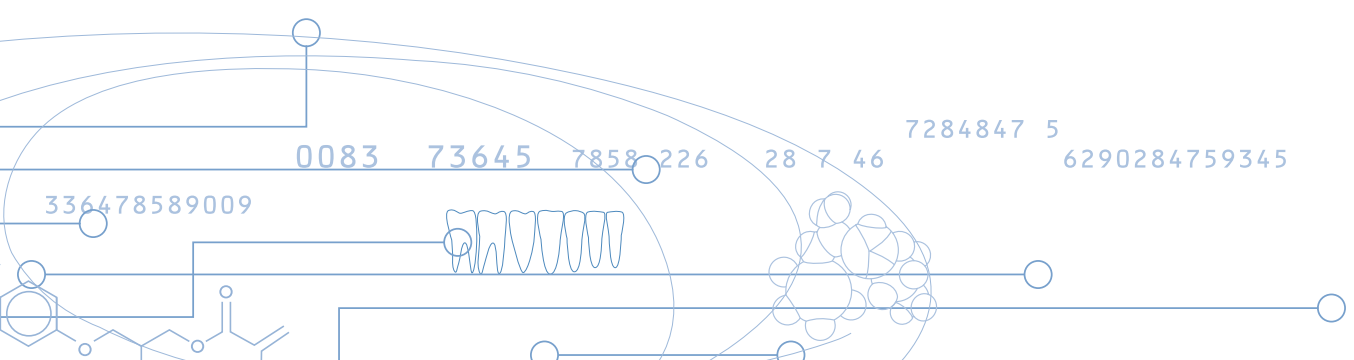

fig. 3 No strength reduction after 3M™ ESPE™ Rocatec™ Soft Treatment (30µm) of 3M™ ESPE™ Lava™ Zirconia initially and after cyclic loading and thermocycling (50N, 1.2 Million cycles).

#### Research summary

There is no strength reduction in Lava zirconia as a result of either sandblasting or Rocatec treatment of the material. In order to optimize the bonding to the cement, Lava zirconia should be sandblasted and/or treated with the Rocatec Soft system. The sandblasting of the outer surface is, however, not necessary or recommended. ▣

1. G.J.P. Fleming, A.R. Curtis and P.M. Marquis (2005) Alumina abrasion and grinding effects on yttrium-stabilized zirconia ceramic, IADR Baltimore, #1339
2. A. R. Curtis, A. J. Wright and G. J.P. Fleming, The influence of surface modification techniques on the bi-axial flexure strength and reliability of a Y-TZP dental ceramic, 2005, submitted
3. J.L.Chapman, D.A.Bulot, A. Sadan and M.B.Blatz (2005) Flexural strength of High-Strength Ceramics after Sandblasting, IADR Baltimore, #1757
4. A. Behrens, H. Nesslerauer and H. Hauptmann (2005) Fracture Strength of Sandblasted and Silicatised Coloured and Non-Coloured Zirconia, IADR Baltimore, #0558





**3M Canada**  
Post Office Box 5757  
London, Ontario N6A 4T1  
Canada  
1-888-363-3685

**3M Center**  
Building 275-2SE-03  
St. Paul, MN 55144-1000  
USA  
1-800-634-2249

**3M ESPE**  
Dental Products  
D-82229 Seefeld  
Germany

3M, ESPE, Espertise, Impregnum, Ketac, Lava and Rocatec are trademarks of 3M or 3M ESPE AG. Used under license in Canada. All rights reserved. © 3M 2007. Please recycle. Printed in Canada.  
Vita, Cercon, President, Procera, E.Max, Digizon and Zirkon are not trademarks of 3M or 3M ESPE AG. BA-07-12443 0711-0415 E